

# TV Connector

## Technical data



The TV Connector is a multimedia streaming device that connects to a TV or other audio source. The low latency transmission from the TV Connector to compatible hearing aids provides excellent stereo sound quality.

### Description

- 1 Volume up and down buttons
- 2 Power button
- 3 Connect button
- 4 LED indicator light
- 5 Micro-USB power port
- 6 Audio port for:
  - Optical (TOSLINK) audio cable
  - Analog 3.5 mm audio cable

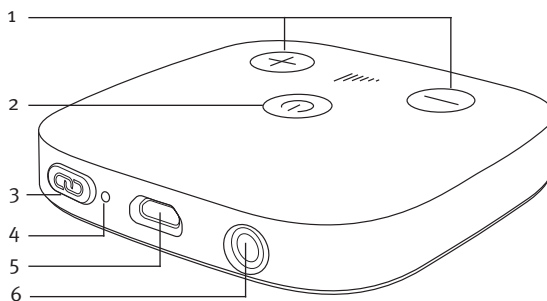

### Package includes:

- Power supply
- Micro-USB cable
- Analog 3.5 mm audio cable
- Optical (TOSLINK) audio cable
- Velcro tape





### Special features

- Automatic connection to hearing aids within range
- Up to 15 m (50 ft) transmission range
- Connect multiple sets of compatible hearing aids simultaneously
- Line-of-sight to hearing aids not necessary
- Support of digital audio signals
- Package includes micro-USB cable, power supply, audio cables and velcro tape

### General information

Dimensions (LxWxH):	63 x 63 x 12 mm (2.5" x 2.5" x 0.46")
Weight:	30 g
Color:	Black
Operating conditions:	0° C to 40° C (+32° F to +104° F). Relative humidity of <90% (noncondensing)
Storage & transportation conditions:	-20° C to 60° C (-4° F to +140° F). Relative humidity of <90% for a long period of time

## LED indicator

Solid green		Powered on and transmitting audio
Solid white		Powered on but no audio transmission (standby mode)
Blinking blue		Connecting mode
Blinking red		Wrong audio input format (DTS)
No LED Indicator		Powered off

## Power supply

Type:	DC, stabilized
Secondary voltage:	5 VDC
Operating current:	500 mA
Plug:	Micro-USB
<b>Important notice:</b>	Only use the original Sonova power supply or a USB certified power supply 5 VDC, ≥ 500 mA

## Audio information

Audio inputs:	Analog (3.5 mm) Optical (TOSLINK)
Audio quality:	Stereo, 120 Hz – 7.3 kHz

## Radio information

Streaming technology:	AirStream™ Technology
Frequency range:	2.4 GHz ISM band
RF power:	100 mW max.
Transmission range:	Up to 15 m (50 ft.)
Max. paired devices:	Unlimited

## Compatibility

The TV Connector may only be used with compatible hearing aid models.

For further information please visit the hearing aid manufacturer's website.

## Standards applied

Europe	EN 300 328 EN 301 489 IEC/EN 60601-1-2 EN 60950-1 IEC/EN 62479
USA	CFR 47, part 15.247 FCC OET Bulletin No.65
Canada	RSS-247 RSS-102
Japan	ARIB-T66

## Connection information

After the TV Connector has been plugged in and powered, please follow the steps to connect new compatible hearing aids.

- 1) Press the connect button on the back of the TV Connector.

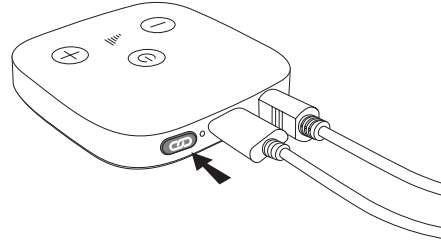

- 2) Make sure the hearing aids are switched on and within 1 m (3 ft) of the TV Connector.

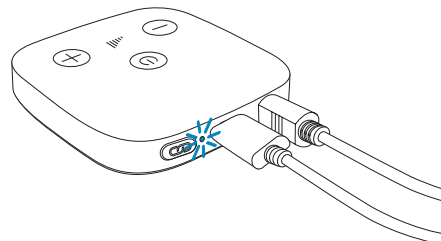

- 3) The hearing aids will play a confirmation melody when the connection is successful.

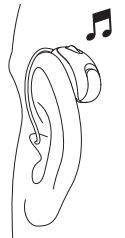

**Note:** The incoming audio signal may need to be accepted by pressing the push button on the hearing aid.

